



## KJS TYPE

### 플라스틱 간편조작형

플라스틱 간편조작형으로 안쪽 Cover가 개폐되어 Cable, Hose 분해설치가 쉬우며, 비교적 간단한 공작기계 및 자동화 설비에 적합 합니다.

### PLASTIC SIMPLE OPERATION TYPE

THE INSIDE COVER OPENS AND SHUTS SO IT'S EASILY DISASSEMBLED AND CABLE AND HOSE ARE EASILY INSTALLED. IT IS AN OPTIMUM PRODUCT FOR A COMPARATIVELY SIMPLE MACHINE TOOL AND AUTOMATION EQUIPMENT.

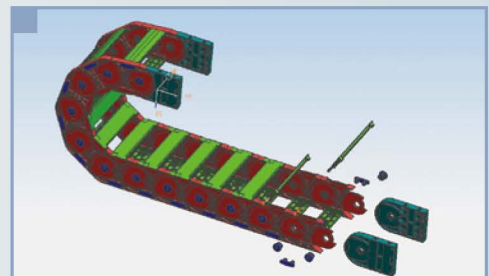

# KJS 045 TYPE

## ⊕ Cablechain / Chain Pitch(P)=45mm

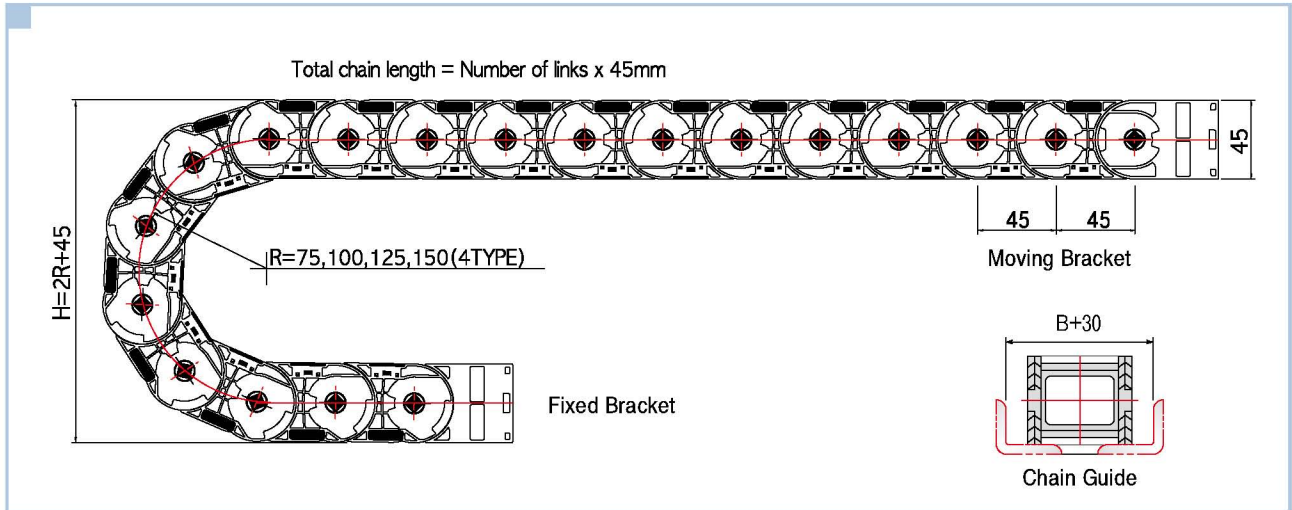

## ⊕ A-A Cross Section / D.Max

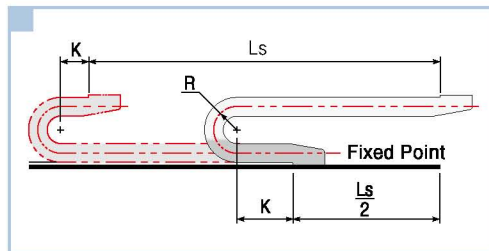
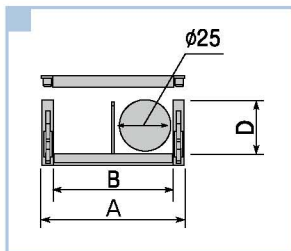

- Chain Length  $L = \frac{Ls}{2} + \pi R + 3P(2K)$
- 곡률반경에 따른 H값

R	75	100	125	150
H	195	245	295	345

단위 mm

SERIES	KJS 045-B50	KJS 045-B75	KJS 045-B100	KJS 045-B125
R	75, 100, 125, 150			
A	68	93	118	143
B	50	75	100	125
D	36			

※ Manufacturing Tolerance of ± 10%

## ⊕ End Bracket (택 1)

Plastic Type

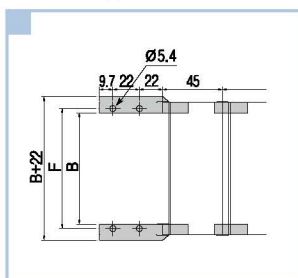

Steel Type

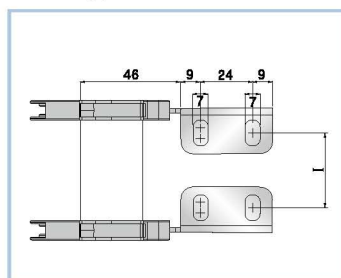

단위 mm

SERIES WITH RODS	F(B+8.5)	I(B-10)
KJS 045-B50	58.5	40
KJS 045-B75	83.5	65
KJS 045-B100	108.5	90
KJS 045-B125	133.5	115

## ⊕ Order Example [ 주문예 ]

KJS 045-B50 / Type ➤ R75 / Radius ➤ 50L/K / Length ➤ 3Sets(P/S) / Q'ty

## ⊕ Cablechain / Chain Pitch(P)=65mm

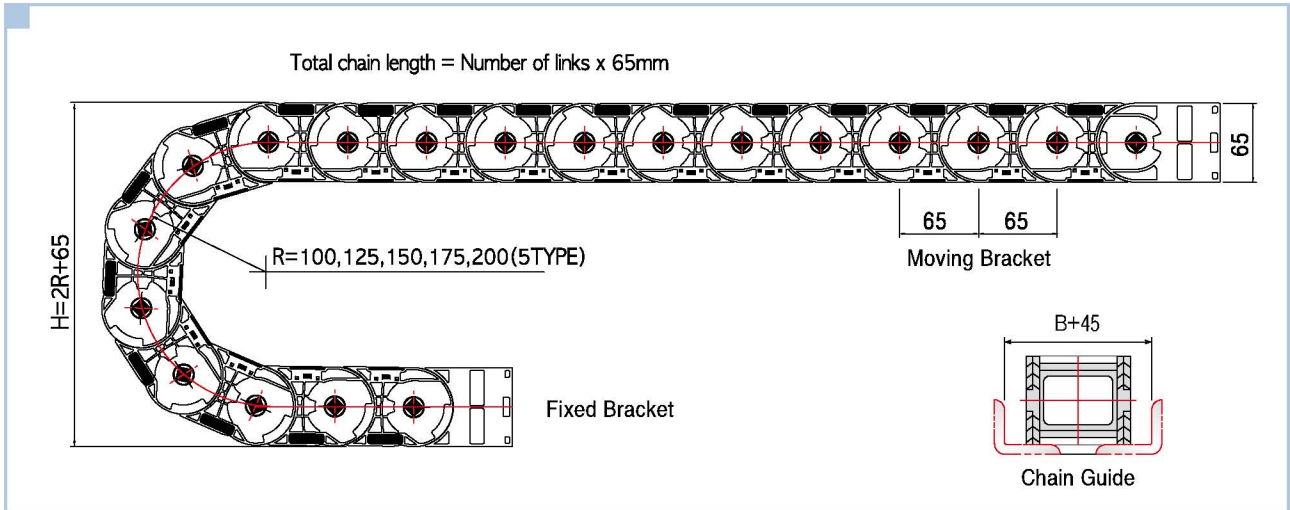

## ⊕ A-A Cross Section / D.Max

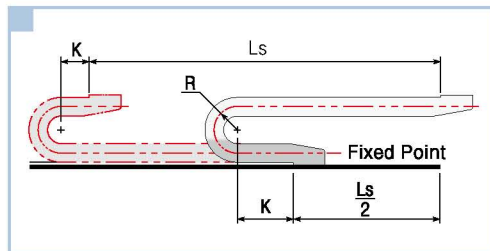
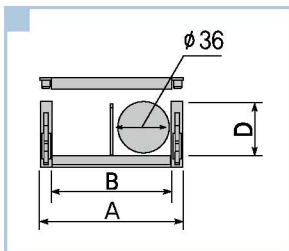

- Chain Length  $L = \frac{Ls}{2} + \pi R + 3P(2K)$
- 곡률반경에 따른 H값

R	100	125	150	175	200
H	265	315	365	415	465

단위 mm

SERIES	KJS 065-B75	KJS 065-B100	KJS 065-B125	KJS 065-B150
R	100, 125, 150, 175, 200			
A	102	127	152	177
B	75	100	125	150
D	52			

※ Manufacturing Tolerance of ± 10%

## ⊕ End Bracket (택 1)

Plastic Type

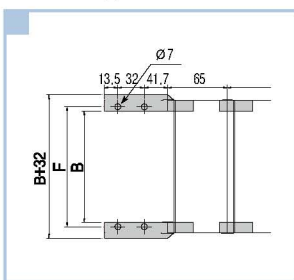

Steel Type

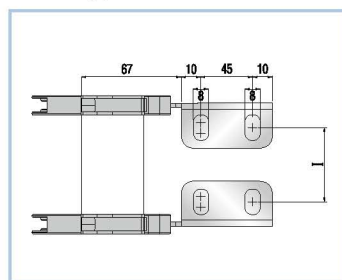

단위 mm

SERIES WITH RODS	F(B+12)	I(B-15)
KJS 065-B75	87	60
KJS 065-B100	112	85
KJS 065-B125	137	110
KJS 065-B150	162	135

## ⊕ Order Example [ 주문예 ]

KJS 065-B100 / Type ➤ R150 / Radius ➤ 50L/K / Length ➤ 5Sets / Q'ty

# KJS 090 TYPE

## ⊕ Cablechain / Chain Pitch(P)=90mm

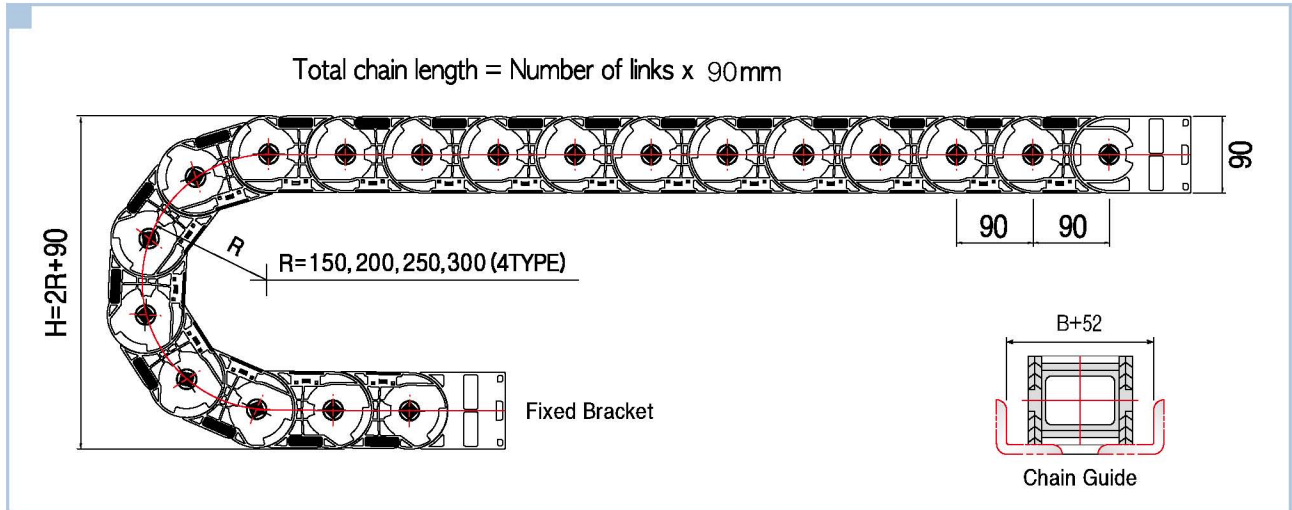

## ⊕ A-A Cross Section / D.Max

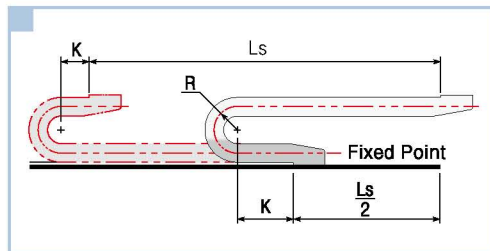
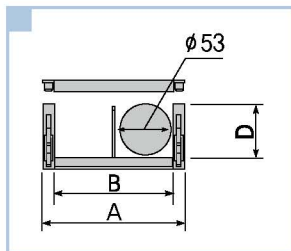

- Chain Length  $L = \frac{Ls}{2} + \pi R + 3P(2K)$
- 곡률반경에 따른 H값

R	150	200	250	300
H	390	490	590	690

단위 mm

SERIES	KJS 090-B118	KJS 090-B168	KJS 090-B218	KJS 090-B268
R	150, 200, 250, 300			
A	150	200	250	300
B	118	168	218	268
D	72			

※ Manufacturing Tolerance of ± 10%

## ⊕ End Bracket (택 1)

Plastic Type

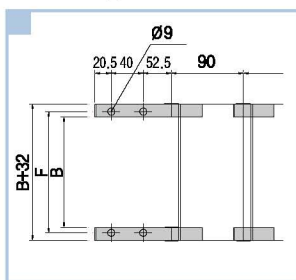

Steel Type

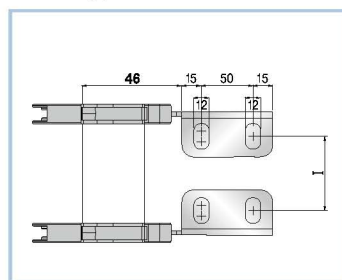

단위 mm

SERIES WITH RODS	F(B+13)	I(B-24)
KJS 090-B118	131	94
KJS 090-B168	181	144
KJS 090-B218	231	194
KJS 090-B268	281	244

## ⊕ Order Example [ 주문예 ]

KJS 090-B118 / Type ➤ R200 / Radius ➤ 40L/K / Length ➤ 10Sets / Q'ty